



AMT MACHINE TOOLS LIMITED

73 Galaxy Blvd., Units 16 & 17
Rexdale, Ontario M9W 5T4

Tel: (416) 675-7760
Fax: (416) 675-6988

FILTERMIST *S*SERIES OIL MIST FILTER

MODEL S400





S400 Specifications	
Airflow	275 CFM
Motor	.55 kW, 3 Phase, 50/60 Hz 208V 230V 460V 575V
Weight	14 Kg.
Noise Level	65 dBA
Inlet Diameter	6"

S400 Mounting Options	
Direct Mount	Hardware included
Floor Stand	specify height required
Wall Mount	use BACS26 Bracket
Machine Side Mount	use BACS26 Bracket
Suspended	N/A

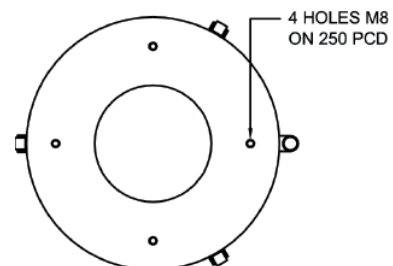
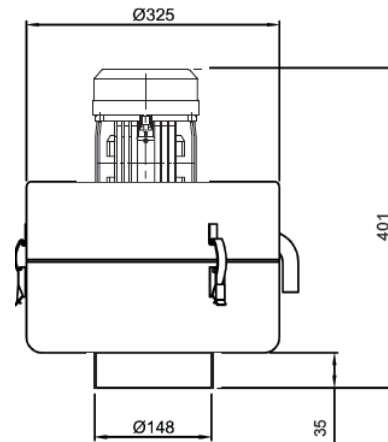







- Used primarily on small enclosed CNC Machines
- Designed for direct mounting on the top of machine for hassle free installation
- Can also be mounted on a stand or mounting bracket where space on top of the machine is limited
- Unit comes complete with collar seal, mounting hardware and oil return hose

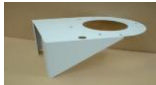

Model S400

Description		Part No.
	<p>S400 Filtermist Unit Complete with all mounting hardware for direct mounting. Motor – 230/460/3/60</p>	S400 230/460
	<p>S400 Filtermist Unit Complete with all mounting hardware for direct mounting. Motor – 575/3/60</p>	S400 575
Stainless Steel Models available upon request		

S400 Accessories

Description		Part No.
	<p>Afterfilter Collects dry smoke.</p>	2000AFA
	<p>Mounting Bracket Used to mount on side of machine or on a wall.</p>	BACS26
	<p>Mounting Stand Used to mount unit next to machine. Specify height.</p>	Stand - specify height
	<p>Oil Return Hose Returns oil to machine. Sold by the foot.</p>	BACD11
	<p>Flexible Ducting Oil resistant hose with wire reinforcement. 4", 6", 8" dia.</p>	<p>4" Dia. BACD14 6" Dia. BACD16 8" Dia. BACD18</p>
	<p>Hose Clamps Used to connect flexible hose to accessories.</p>	<p>4" Dia. BACC14 6" Dia. BACC16 8" Dia. BACC18</p>
	<p>Y Adaptors For multiple collection points. Available in: 4"x4"x4", 6"x4"x4" or 8"x6"x6"</p>	<p>4"x4"x4" BACY44 6"x4"x4" BACY64 8"x6"x6" BACY86 Other sizes on request.</p>
	<p>Flanged Apaptors To secure ducting to a machine. Available in 4", 6", 8" diameters.</p>	<p>4" Dia. BACA14 6" Dia. BACA16 8" Dia. BACA18</p>
	<p>Fishtails For collection on open machines. 4", 6", 8" diameters.</p>	<p>4" Dia. BACH14 6" Dia. BACH16 8" Dia. BACH18</p>

