



# FILTERMIST XCEL 2

## MODEL FX4002





FX4002 Specifications	
Airflow	900 CFM
Motor	1.5 kW, 3 Phase, 50/60 Hz
	208V
	230V
	460V
	575V
Weight	23 Kg.
Noise Level	70 dBA
Inlet Diameter	6"

FX4002 Mounting Options	
Direct Mount	use 4000DMK Direct Mount Kit
Floor Stand	specify height required
Wall Mount	use BACS46 Bracket
Machine Side Mount	use BACS46 Bracket
Suspended	use BACS20 Suspension Kit

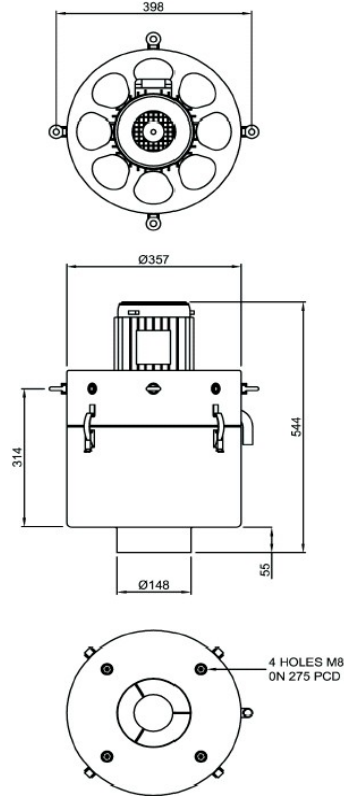









- Used on open machines and larger CNC Machines
- Designed for mounting on a stand next to the machine where top of machine installation is not possible
- Can also be mounted directly on top of machine if space permits or on a mounting bracket
- Y Junction can be used where more than one intake point is required



# Model FX4002

Description	Part No.
 <p><b>FX4002 FiltermistXcel Unit</b> Motor – 230/460/3/60</p>	<b>FX4002 230/460</b>
 <p><b>FX4002 FiltermistXcel Unit</b> Motor – 575/3/60</p>	<b>FX4002 575</b>
Stainless Steel Models available upon request	

## FX4002 Accessories

Description	Part No.
 <p><b>Afterfilter</b> Collects dry smoke.</p>	<b>3000AFA</b>
 <p><b>Direct Mounting Kit</b> Includes foam collar, mounting studs and hardware.</p>	<b>4000DMK</b>
 <p><b>Mounting Bracket</b> Used to mount on side of machine or on a wall.</p>	<b>BACS46</b>
 <p><b>Mounting Stand</b> Used to mount unit next to machine. Specify height.</p>	<b>Stand - specify height</b>
 <p><b>Oil Return Hose</b> Returns oil to machine Sold by the foot.</p>	<b>BACD11</b>
 <p><b>Flexible Ducting</b> Oil resistant hose with wire reinforcement. 4", 6", 8" dia.</p>	<b>4" Dia. BACD14</b> <b>6" Dia. BACD16</b> <b>8" Dia. BACD18</b>
 <p><b>Hose Clamps</b> Used to connect flexible hose to accessories.</p>	<b>4" Dia. BACC14</b> <b>6" Dia. BACC16</b> <b>8" Dia. BACC18</b>
 <p><b>Y Adaptors</b> For multiple collection points. Available in: 4"x4"x4", 6"x4"x4" or 8"x6"x6"</p>	<b>4"x4"x4" BACY44</b> <b>6"x4"x4" BACY64</b> <b>8"x6"x6" BACY86</b> <small>Other sizes on request.</small>
 <p><b>Flanged Apaptors</b> To secure ducting to a machine. Available in 4", 6", 8" diameters.</p>	<b>4" Dia. BACA14</b> <b>6" Dia. BACA16</b> <b>8" Dia. BACA18</b>
 <p><b>Fishtails</b> For collection on open machines. 4", 6", 8" diameters.</p>	<b>4" Dia. BACH14</b> <b>6" Dia. BACH16</b> <b>8" Dia. BACH18</b>



### AMT MACHINE TOOLS LIMITED

73 Galaxy Blvd., Units 16 & 17  
Rexdale, Ontario M9W 5T4  
www.amtmachine.com

Tel: (416) 675-7760  
Fax: (416) 675-6988  
sales@amtmachine.com