



AMT MACHINE TOOLS LIMITED

73 Galaxy Blvd., Units 16 & 17
Rexdale, Ontario M9W 5T4

Tel: (416) 675-7760
Fax: (416) 675-6988

FILTERMIST XCEL 2

MODEL FX5002





FX5002 Specifications	
Airflow	1200 CFM
Motor	2.2 kW, 3 Phase, 50/60 Hz 208V 230V 460V 575V
Weight	29 Kg.
Noise Level	72 dBA
Inlet Diameter	8"

FX5002 Mounting Options	
Direct Mount	use 5000DMK Direct Mounting Kit
Floor Stand	specify height required
Wall Mount	use BACS46 Bracket
Machine Side Mount	use BACS46 Bracket
Suspended	use BACS20 Suspension Kit

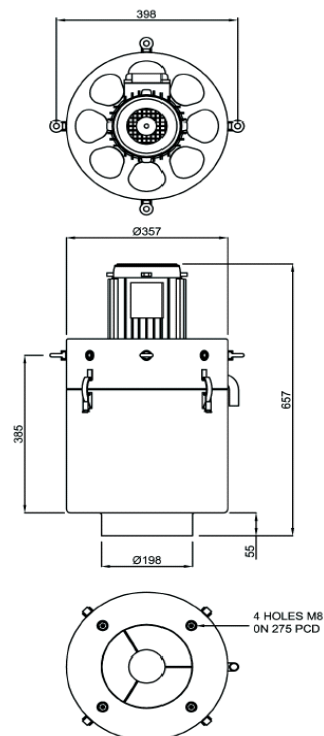









- Used on open machines and larger CNC Machines
- Designed for mounting on a stand next to the machine where top of machine installation is not possible
- Can also be mounted directly on top of machines or on a mounting bracket
- Y Junction can be used where more than one intake point is required



Model FX5002

Description		Part No.
	FX5002 FiltermistXcel Unit Motor – 230/460/3/60	FX5002 230/460
	FX5002 FiltermistXcel Unit Motor – 575/3/60	FX5002 575
Stainless Steel Models available upon request		

FX5002 Accessories

Description		Part No.
	Afterfilter Collects dry smoke.	3000AFA
	Direct Mounting Kit Includes foam collar, mounting studs and hardware.	5000DMK
	Mounting Bracket Used to mount unit on side of machine or on a wall.	BACS46
	Mounting Stand Used to mount unit next to machine. Specify height.	Stand - specify height
	Oil Return Hose Returns oil to machine. Sold by the foot.	BACD11
	Flexible Ducting Oil resistant hose with wire reinforcement. 4", 6", 8" dia.	4" Dia. BACD14 6" Dia. BACD16 8" Dia. BACD18
	Hose Clamps Used to connect flexible hose to accessories.	4" Dia. BACC14 6" Dia. BACC16 8" Dia. BACC18
	Y Adaptors For multiple collection points. Available in: 4"x4"x4", 6"x4"x4" or 8"x6"x6".	4"x4"x4" BACY44 6"x4"x4" BACY64 8"x6"x6" BACY86 Other sizes on request.
	Flanged Adaptors To secure ducting to a machine. Available in 4", 6", 8" diameters.	4" Dia. BACA14 6" Dia. BACA16 8" Dia. BACA18
	Fishtails For collection on open machines. 4", 6", 8" diameters.	4" Dia. BACH14 6" Dia. BACH16 8" Dia. BACH18



AMT MACHINE TOOLS LIMITED

73 Galaxy Blvd., Units 16 & 17
Rexdale, Ontario M9W 5T4
www.amtmachine.com

Tel: (416) 675-7760
Fax: (416) 675-6988
sales@amtmachine.com