



AMT MACHINE TOOLS LIMITED

73 Galaxy Blvd., Units 16 & 17
Rexdale, Ontario M9W 5T4

Tel: (416) 675-7760
Fax: (416) 675-6988

FILTERMIST *S*SERIES OIL MIST FILTER

MODEL S800





S800 Specifications	
Airflow	550 CFM
Motor	.66 kW, 3 Phase, 50/60 Hz 208V 230V 460V 575V
Weight	16 Kg.
Noise Level	67 dBA
Inlet Diameter	6"

S800 Mounting Options	
Direct Mount	Hardware included
Floor Stand	specify height required
Wall Mount	use BACS26 Bracket
Machine Side Mount	use BACS26 Bracket
Suspended	N/A

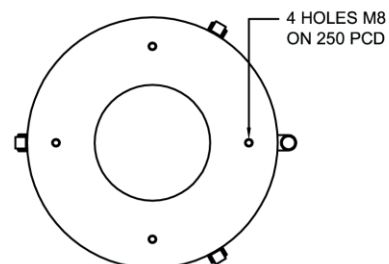
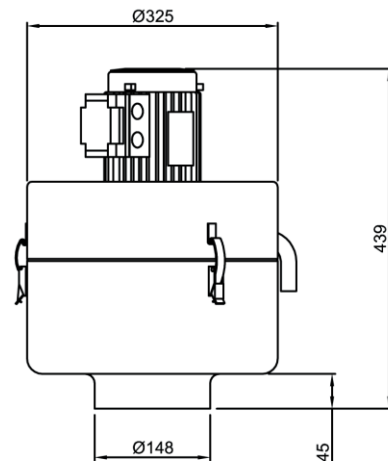







- Used primarily on small enclosed CNC Machines
- Designed for direct mounting on the top of machine for hassle free installation
- Can also be mounted on a stand or mounting bracket.
- Unit comes complete with collar seal, mounting hardware and oil return hose



Model S800

Description		Part No.
	<p>S800 Filtermist Unit Complete with all mounting hardware for direct mounting. Motor – 230/460/3/60</p>	S800 230/460
	<p>S800 Filtermist Unit Complete with all mounting hardware for direct mounting. Motor – 575/3/60</p>	S800 575
Stainless Steel Models available upon request		

S800 Accessories

Description		Part No.
	<p>Afterfilter Collects dry smoke.</p>	2300AFA
	<p>S Fusion Afterfilter For neat oil or high pressure</p>	S Fusion
	<p>Mounting Stand Used to mount unit next to machine. Specify height.</p>	Stand - specify height
	<p>Oil Return Hose Returns oil to machine Sold by the foot.</p>	BACD11
	<p>Flexible Ducting Oil resistant hose with wire reinforcement. 4", 6", 8" dia.</p>	<p>4" Dia. BACD14 6" Dia. BACD16 8" Dia. BACD18</p>
	<p>Hose Clamps Used to connect flexible hose to accessories.</p>	<p>4" Dia. BACC14 6" Dia. BACC16 8" Dia. BACC18</p>
	<p>Y Adaptors For multiple collection points. Available in: 4"x4"x4", 6"x4"x4" or 8"x6"x6"</p>	<p>4"x4"x4" BACY44 6"x4"x4" BACY64 8"x6"x6" BACY86 Other sizes on request.</p>
	<p>Flanged Apaptors To secure ducting to a machine. Available in 4", 6", 8" diameters.</p>	<p>4" Dia. BACA14 6" Dia. BACA16 8" Dia. BACA18</p>
	<p>Fishtails For collection on open machines. 4", 6", 8" diameters.</p>	<p>4" Dia. BACH14 6" Dia. BACH16 8" Dia. BACH18</p>



AMT MACHINE TOOLS LIMITED
73 Galaxy Blvd., Units 16 & 17
Rexdale, Ontario M9W 5T4
www.amtmachine.com

Tel: (416) 675-7760
Fax: (416) 675-6988
sales@amtmachine.com